



ORTHOPAEDIC
SURGERY

AESCULAP[®] Metha[®]

SHORT HIP STEM SYSTEM

EVOLVING THE STATE OF ARTHROPLASTY

AESCULAP® Metha®

EVOLVING THE STATE OF ARTHROPLASTY





CONTENTS

SHORT HIP STEM	4
SHORT STEM ANCHORING CONCEPT	6
IMPLANT RANGE	8
LESS INVASIVE APPROACHES	10
IMPLANTATION TECHNIQUE	12
FEMORAL OSTEOTOMIE AND OPENING THE MEDULLARY CAVITY	14
IMPLANT- AND RASP POSITION	16
TRIAL REDUCTION AND STEM IMPLANTATION	18
HANDLES FOR DIFFERENT APPROACHES	20
INSTRUMENTS AND IMPLANTS	22

AESFULAP[®] Metha[®]

SHORT HIP STEM

SYSTEM



Metha[®] 135°



Metha[®] 130°



Metha[®] 120°

➤ The Metha[®] prosthesis represents a short stem hip implant for cementless implantation. It combines two Aspects: small stem size and a circumferential coating. As a result, it supports less invasive procedures.

The design continues on the positive experience with non-cemented stems fixated by metaphyseal anchoring. The prosthesis concept allows implantation via the base of the femoral neck, with conservative treatment of the bone in the femoral neck and in the greater trochanter region, preserving the bone, soft tissue and muscle. While the position of the Metha[®] stem leads to primary load stability, the PLASMAPORE[®] μ -CaP coating of the entire proximal surface supports rapid secondary fixation (1).

The Metha[®] implantation instruments are stored in one tray. With the combination of Metha[®] and the AESFULAP[®] acetabular cup system Plasmafit[®] the surgeon has the intraoperative option for of a 36 mm Ceramic | Vitelene[®] articulation from cup size 50 on.

(1) Winkler-Gniewek W; PLASMAPORE coating for cement-free bonding of joint endoprotheses; Scientific Information, AESFULAP-Wissenschaftliche-Information, Nov 1989 (22).



AESCULAP® Metha®

SHORT STEM ANCHORING CONCEPT

METAPHYSIS

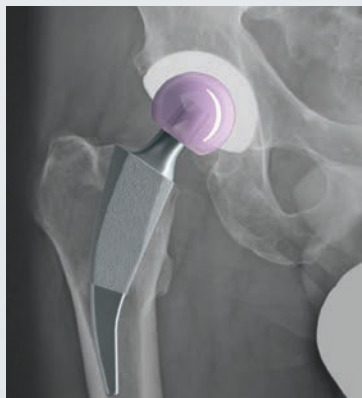

➤ To support osteointegration, the Metha® stem carries a circumferential PLASMAPORE® μ -CaP coating. This layer has an osteoconductive effect and accelerates contact between the bone and the prosthesis stem (1).

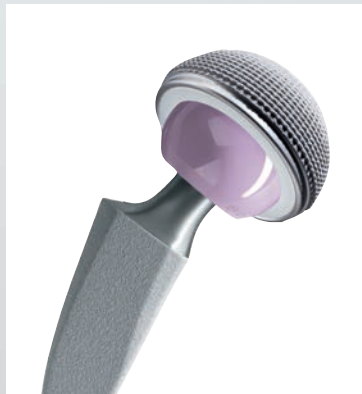

➤ The non-cemented stem is fixated by metaphyseal anchoring within the closed ring of the femoral neck. ① The greater trochanter region remains almost untouched. Bone and muscle structures are preserved – a particular bonus for young and active patients with good bone structure. The conical shape supports primary stability and proximal load transfer. ② The primary stability is further enhanced by the rounded tip of the stem guided along the dorso-lateral cortex. ③

(1) Winkler-Gniewek W; PLASMAPORE coating for cement-free bonding of joint endoprotheses; Scientific Information, AESCULAP-Wissenschaftliche-Information, Nov 1989 (22).

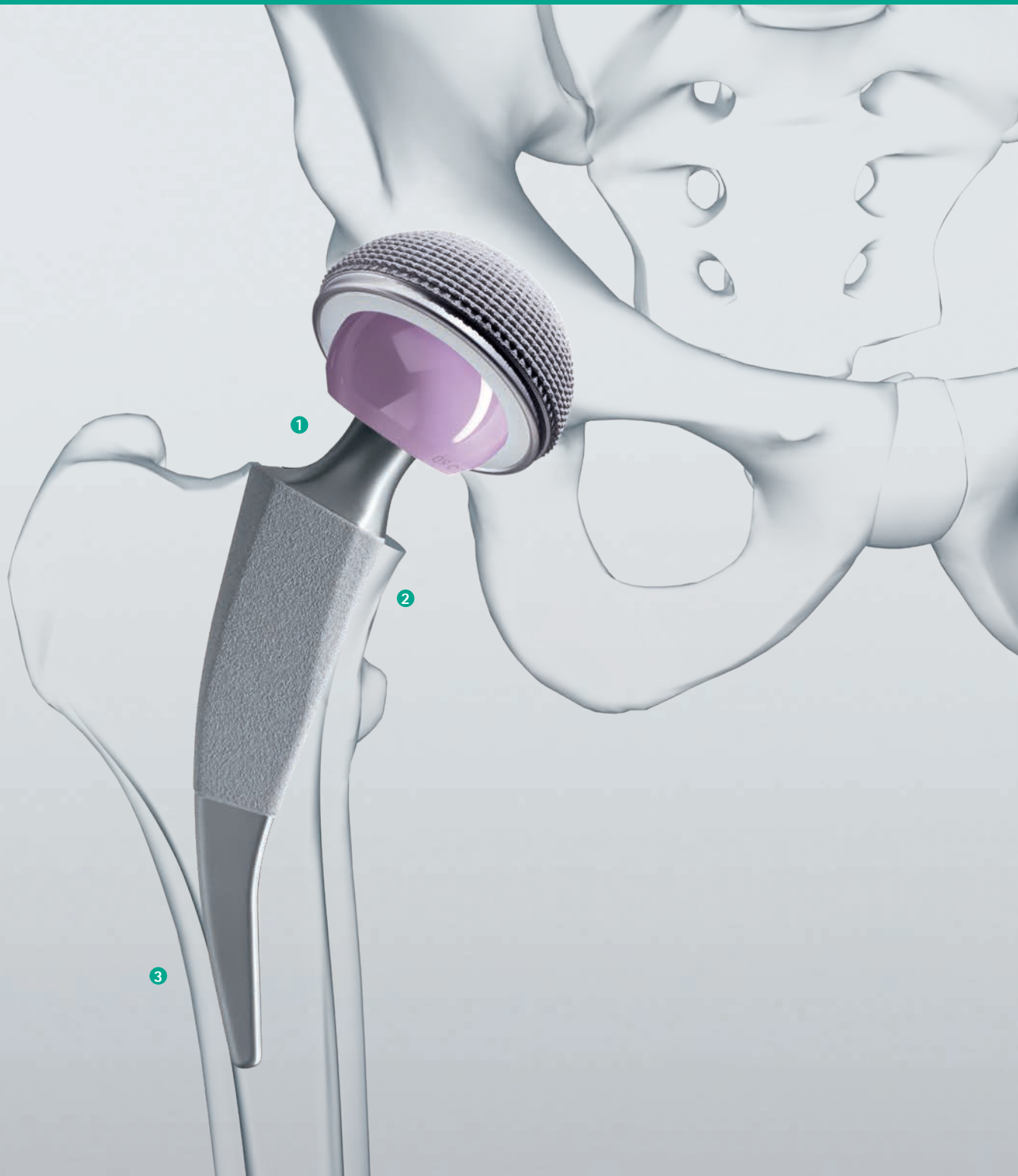

AESCULAP® Metha®

IMPLANT RANGE

IMPLANTS

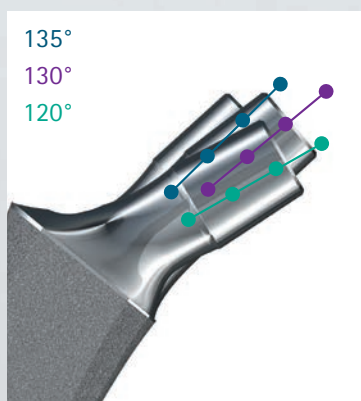

➤ Metha® variability

The three CCD angle specifications of 135°, 130° and 120° of the Metha® system provide a variety of offset options for the stem implantation. The varus-valgus variability of the Metha® stem position of approximately 20° allows further adaptation to the patient-specific hip joint reconstruction.

➤ Metha® implants

The sizes in the implant range increase in increments of 1.5 mm in the A/P projection and 1.2 mm in the lateral projection. Anchorage in the closed femoral neck is supported by the conical shape in the lateral view. The difference in nominal length between the smallest and largest implant is only 25 mm.

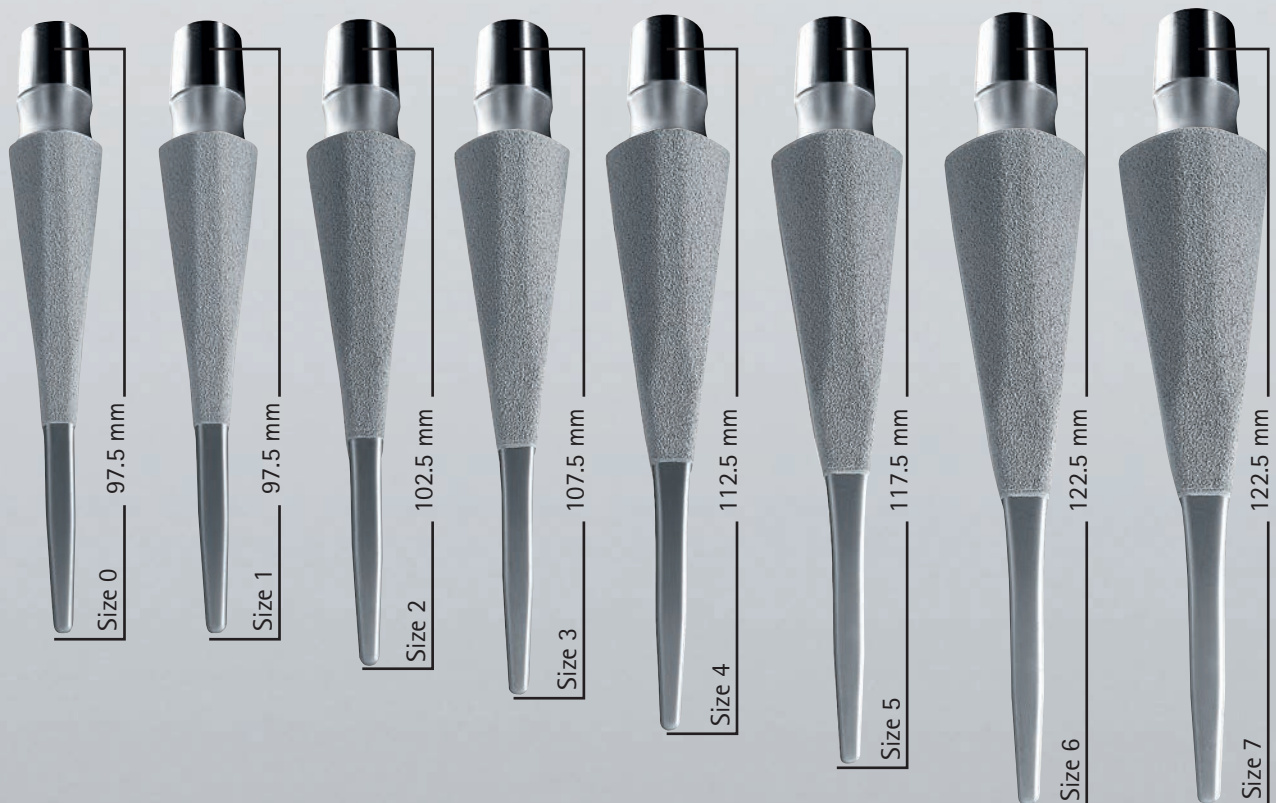



AESCULAP® Metha®

LESS INVASIVE APPROACHES

INSTRUMENTS

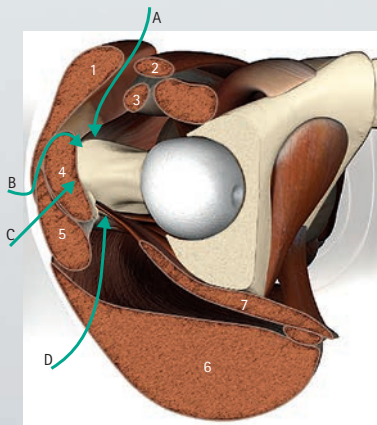

➤ Simple and clear instrumentation is a distinguishing feature of the Metha® stem. Because of the more medial location of the femur opening and the medially tilted insertion angle, the Metha® prosthesis supports minimally invasive and less invasive implantation techniques.

The MIOS® (Minimally Invasive Orthopaedic Solutions) instrument range has been specially designed for less invasive procedures and for Metha®. MIOS® retractors, curved instrument profiles and the Metha® rasp handles (see page 20) facilitate all widely used approaches to the hip joint.

In supine position the antero-lateral, the direct lateral and the direct anterior approach are possible. The lateral position allows the direct lateral, antero-lateral and posterior approaches.

- | | |
|---------------------------|--------------------------------|
| 1 M. tensor fasciae latae | A Direct anterior |
| 2 M. sartorius | B Antero-lateral |
| 3 M. rectus femoris | C Direct-lateral, transgluteal |
| 4 M. gluteus minimus | D Posterior |
| 5 M. gluteus medius | |
| 6 M. gluteus maximus | |
| 7 M. piriformis | |



AESCULAP® Metha®

IMPLANTATION TECHNIQUE

PRE OPERATIVE PLANNING

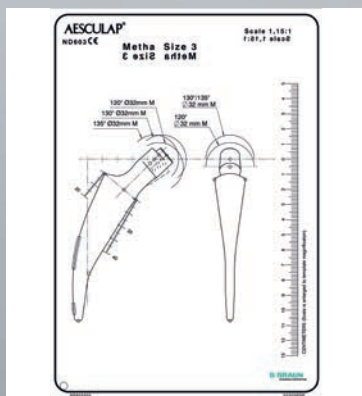
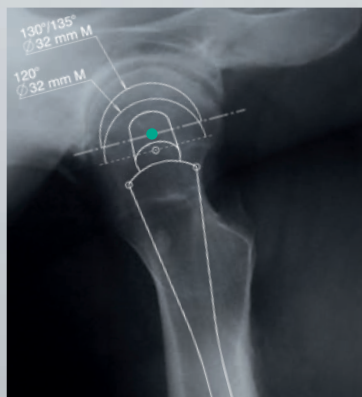

ND603

Indications and bone morphology

The Metha® stem is a cementless implant. The spectrum of indications includes degenerative coxarthrosis, rheumatoid arthritis and femoral head necrosis. Good bone quality is a prerequisite for the implantation. Coxa vara bone morphologies and coxa valga dysplasia are also suitable.

The pre operative assessment should also take a wide femoral neck, especially in the presence of other concerns regarding the osteotomy level or the implant size into account. An under-sized stem could lead to reduced primary stability. Any strong antetorsion of the femoral neck can complicate the implantation even for short stems.

Pre Operative planning

X-ray templates at a scale of 1.15:1 are available in printed as well as digital format for planning the size of the Metha® short hip stem prosthesis. In addition to filling the femoral neck area, the aim is to achieve support on the calcar as well as surface contact between the distal end of the stem and the lateral cortex.

In addition to the position of the joint center and the leg length, the planning of the resection height also takes into account the preservation of the approx. 2 - 10 mm thick ring of cortex around the femoral neck that is important for anchorage. The osteotomy of the femoral neck is performed at an angle of 50° to the femoral shaft axis. For intraoperative orientation, the distance from the lesser trochanter can be measured medially.

In the lateral X-ray, the objective is to wedge firmly in the proximal femur. The Metha® short hip stem is guided by the femoral neck and positioned according to this, almost parallel to the antetorsion angle of the femur.



AESCULAP® Metha®

FEMORAL OSTEOTOMIE AND OPENING THE MEDULLARY CAVITY

OSTEOTOMY

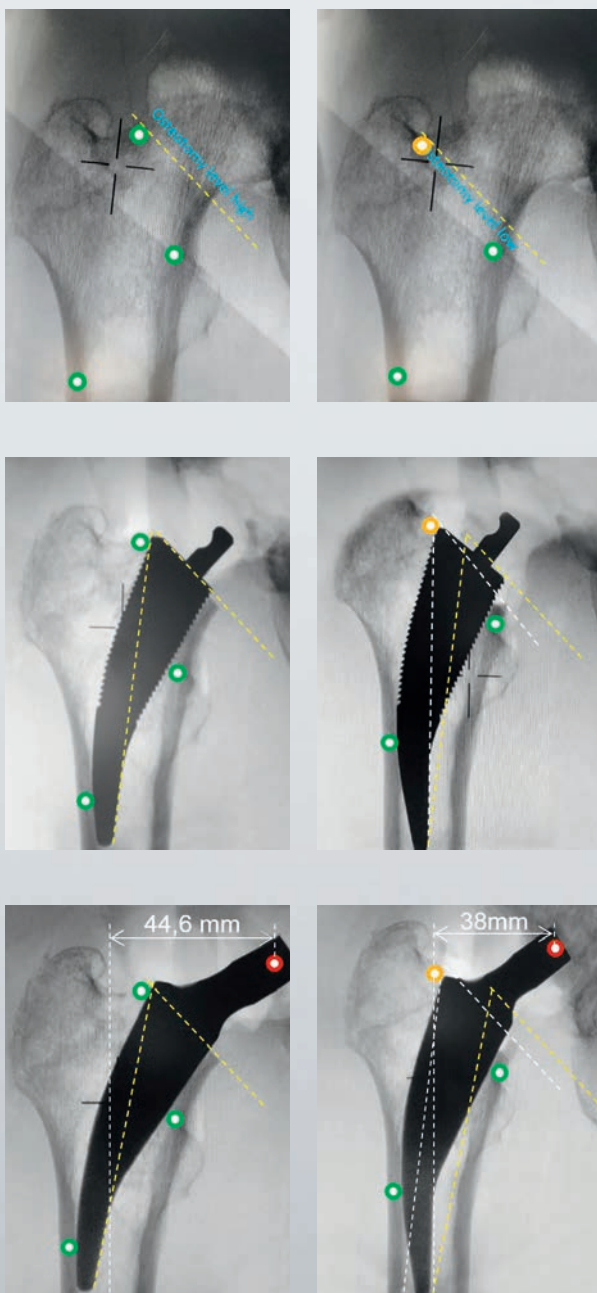

➤ Femoral osteotomy

The femoral neck resection is performed according to pre operative planning, usually starting approx. 10 mm above the junction of the greater trochanter and the femoral neck, and is carried out at an angle of 50° to the femoral axis. Care must be taken that a closed cortical ring of the femoral neck of at least 2 mm lateral width is left intact.

Any lower resection than described above, can compromise the prosthesis anchoring and therefore demonstrates a contraindication against the implantation. If the osteotomy is applied too low medially or, in other words, the osteotomy is too steep, the stem will have to rest on a smaller medial bone surface. For this stem position, the primary stability arises from the cortical lateral support in the closed ring of the femoral neck.

The deeper the osteotomy, the less is the system is guided inside the femoral neck.

A higher osteotomy resection can be chosen for the reconstruction of the horizontal offset, in case of a corresponding anatomical medial calcar support (see pictures left).

The orientation of the implantation depth on a too deep calcar osteotomy can increase the risk of a stem position without lateral support. This can result in a tendency to move the rasp or prosthesis stem into valgus.



- To position the osteotomy position, the Metha® resection guide or a double osteotomy technique can be used.

The Metha® resection guide is placed from anterior direction onto the proximal femur and is guided by the guide rod onto the trochanteric fossa, which needs to be preserved. The attached handle is parallel to the resection guide and should be oriented so that it is also parallel to the axis of the femur. In this position, the osteotomy can be performed.

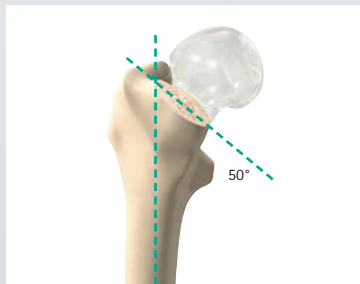

Alternatively or additionally, a double osteotomy can also be performed. A first, subcapital osteotomy can be carried out in situ. The second osteotomy is guided by the planned implantation depth and stem position. A trapezoidal second osteotomy (posterior higher than anterior) allows to influence of the antetorsion position and facilitates the insertion of the rasps.



- **Opening the medullary cavity**

The medullary cavity is opened with an awl. The opening point is at the center of the osteotomy plane. The awl is advanced to the lateral cortex with light twisting movements. It can be helpful to insert the awl in a slightly varus first, then straighten it on reaching the lateral cortex before pushing it distally along the lateral cortex. The marker dots on the awl are for depth orientation and correspond to the resection height for the small (size 0) or larger (size 7) Metha® stem. The curvature of the awl resembles the lateral profile of the implant, so that it produces a first impression of the subsequent implant bed. The awl also defines the working direction for the rasps.

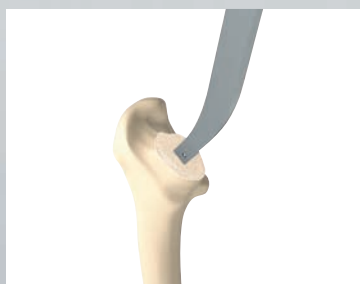

A second awl with a thicker anterior-posterior profile is available for easier bone preparation in harder structures. As a general rule, the awls are for manual application only and must not be impacted with a mallet.

AESCULAP® Metha®

IMPLANT- AND RASP POSITION

POSITION



➤ Valgus/Varus variability

The Metha® short hip stem can be implanted at various relative valgus or varus positions to fit the respective bone shape and implant size. The neutral position is defined as parallel to a 50° femoral osteotomy.

Other implant positions are up to 15° relative valgus or 5° relative varus.

When preparing the medullary cavity, a position change of the rasp can be detected by intraoperative comparison with the osteotomy plane.

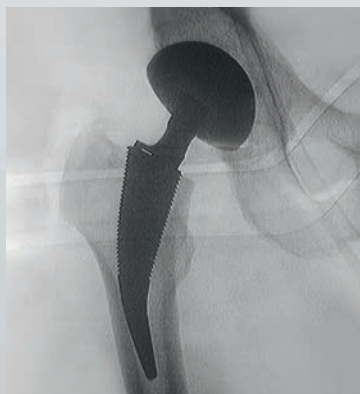

> Femur preparation

The implant bed is prepared in stages, beginning with the smallest rasp. The rasp is introduced centrally into the opening in the medullary canal, observing the antetorsion. During insertion the tip of the rasp should touch the lateral cortex and run along it.

To control the tendency towards valgus of the instrument, it helps to apply slight varus pressure when inserting the rasps. The position and alignment of the osteotomy can be checked after inserting the first rasp. Valgus positioning of the rasp can cause unintended leg lengthening. This has to be considered when carrying out the pre operative planning and during the intraoperative selection of the next rasp size. The lateral boundary of the osteotomy must never be removed by any additional resection. To assess such a resection, a proper visibility of the lateral femoral neck is essential.

The implant bed is of the correct size as soon as the rasp touches the lateral cortex, sits firmly in the femoral neck, and can not rotate anymore. The teeth of the rasp should be ideally aligned to the resection level, but never below the osteotomy plane.

The position of the rasp can be checked by fluoroscopy.

If the rasp is not in contact with the dorsolateral cortex in any plane (fluoroscopy picture with internal rotation), the position should be corrected by carefully inserting a bigger rasp under slight varus pressure.

AESCULAP® Metha®

TRIAL REDUCTION AND STEM IMPLANTATION

RECONSTRUCTION

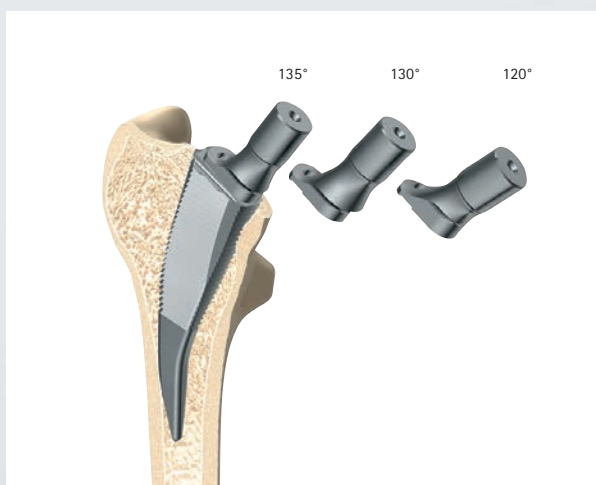

➤ Trial reduction

The trial reduction is carried out with modular trial neck adapters, which are clipped on the rasp. There are three neck adapters available with various CCD angles (130°, 135°, 120°).

While the different CCD angles of 135° and 130° allow the offset to be changed by -5 mm / +5 mm without changing the leg length, the 120° angle helps the leg length to be adjusted without changing the offset. The medium offset is 44 mm.

The appropriate neck adapter is selected by assessing the possibility of a dislocation tendency, the range of movement and the soft tissue or ligamentary tension. The leg length is corrected by choosing a 120° CCD angle and prosthesis heads of the required neck length.

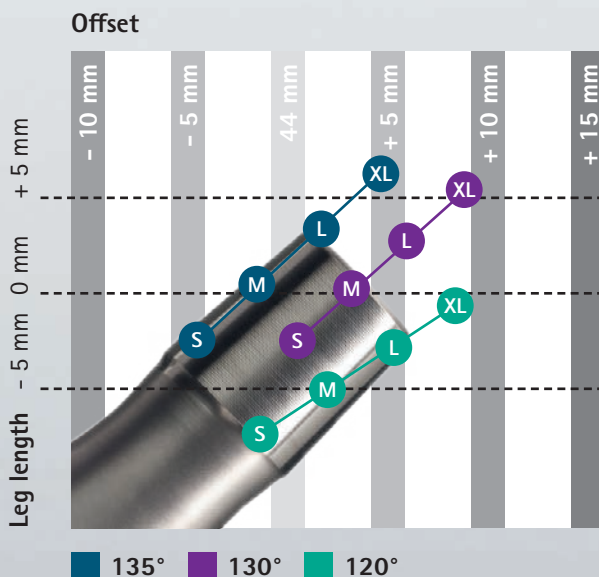



NG930R

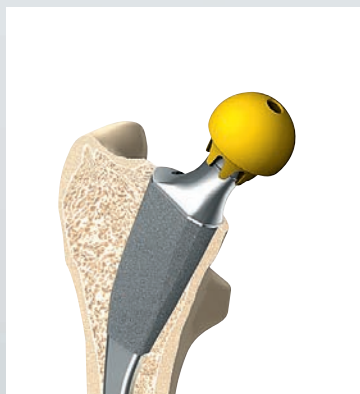

➤ Inserting the Metha® Stem

The prosthesis stem to be implanted is chosen according to the last used rasp size.

The Metha® short stems are available with CCD angles of 135°, 130° and 120°. The implantation starts with the manual insertion of the stem, which is implanted as deep as possible in the femur. Then, the ND401R stem impactor is applied in the taper recess in the load direction of the implant, or the NG930R stem impactor is applied, until the final, secure implantation of the implant is achieved. The prosthesis does not need to be guided here, because it aligns itself accordingly with the position of the rasp. The NG930R stem impactor can be used for slight valgus positioning of the prosthesis.

➤ Trial reduction with Metha® stem

If necessary, an additional trial reduction can be carried out even after the implantation of the Metha® stem, using the color coded trial heads.

➤ Extraction of the Metha® stem

The ND656R instrument can be used for any necessary intraoperative extraction of the Metha® stem. This instrument grips around the 12/14 prosthesis taper and is connected to the ND655R extraction instrument. The prosthesis stem must not be reused after an extraction procedure, because the taper could be damaged during this procedure.

The revision of a Metha® stem is carried out using a standard stem extractor for the 12/14 cone, as with standard hip endoprosthesis stems. This instrument is not included in the Metha® instrument set.

AESCULAP® Metha®

HANDLES FOR DIFFERENT APPROACHES

HANDLES

➤ DIRECT ANTERIOR APPROACH

The less invasive approaches in combination with shorter prosthesis stems are a good alternative in hip replacement procedures and require approach-specific instruments.

The Metha® system offers various instruments adapted to common hip approaches. For the direct anterior approach, specific handles are available with single or double offset.

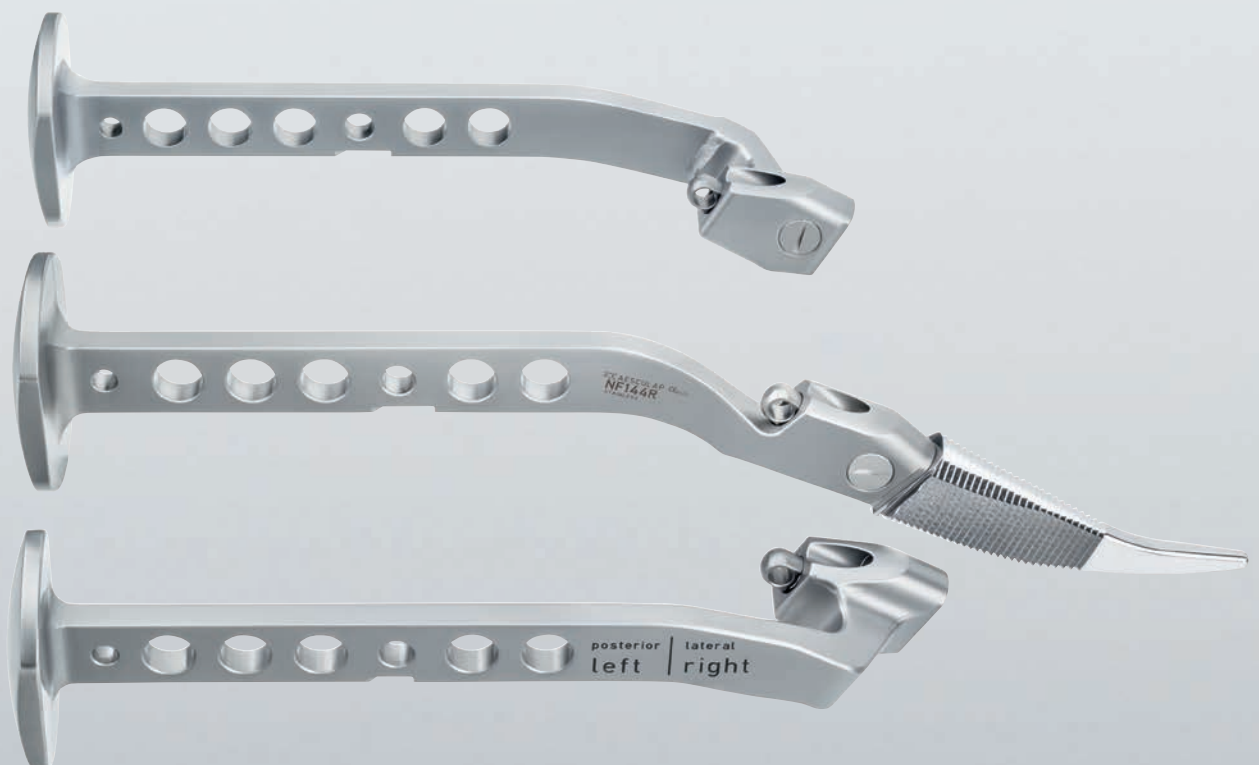



NF180R



NF141R



NF144R



NF142R

AESCULAP® Metha®

INSTRUMENTS AND IMPLANTS

INSTRUMENTS

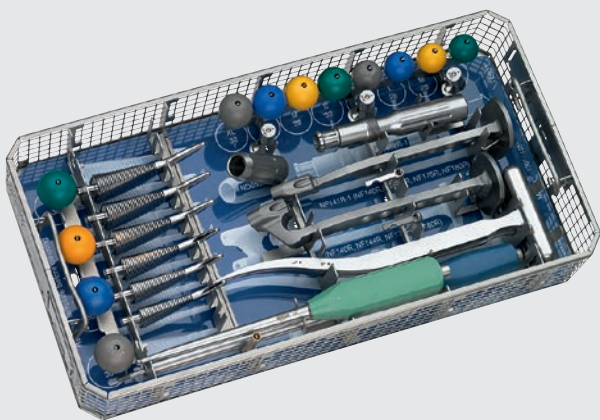

ND608
Metha® set (135° / 130° / 120°)

ND608 Metha® set (135° / 130° / 120°)

Tray for Metha® set (489 x 253 x 74 mm)	ND609R
Packing template for Mono set	TE931
Metha® awl narrow	ND644R
Metha® awl wide	ND645R
Metha® extraction instrument for 12 / 14 taper	ND656R
Metha® handle for the extraction instrument	ND655R
Insertion instrument with triangular head	NG930R
Rasp trial neck adapter 120° / 0°	ND718R
Rasp trial neck adapter 130° / 0°	ND715R
Rasp trial neck adapter 135° / 0°	ND725R
Lid	JH217R*
Metha® resection guide	ND607R*
Metha® awl narrow, anterior approach	ND654R*
Metha® awl wide, anterior approach	ND672R*
Impactor	ND401R*

Metha® rasps

Size	0	1	2	3
	NF090R*	NF181R	NF182R	NF183R
Size	4	5	6	7
	NF184R	NF185R	NF086R	NF087R*

Trial heads 12/14

	28 mm	32 mm	36 mm
Head length S	NG296*	NG306*	NG326*
Head length M	NG297*	NG307*	NG327*
Head length L	NG298*	NG308*	NG328*
Head length XL	NG299*	NG309*	NG329*

Metha[®] rasp handles, also for navigation

straight, lateral approach	NF180R*
curved, posterior approach	NF144R*
offset, left / right (also see page 21)	NF141R*
offset, right / left (also see page 21)	NF142R*
angled, anterior approach	NF140R*
offset right / left, anterior approach	NF139R*
offset left / right, anterior approach	NF138R*

The Metha[®] Mono tray can store 2 rasp handles

Items marked with * must be ordered separately

Recommended container for ND608
AESCULAP[®] Basic container 592 x 274 x 90 mm

AESCULAP® Metha®

INSTRUMENTS AND IMPLANTS

IMPLANTS



Metha® stems with 12/14 taper

Size	CCD = 135°	CCD = 130°	CCD = 120°
0	NC280T	NC270T	NC290T
1	NC281T	NC271T	NC291T
2	NC282T	NC272T	NC292T
3	NC283T	NC273T	NC293T
4	NC284T	NC274T	NC294T
5	NC285T	NC275T	NC295T
6	NC286T	NC276T	NC296T
7	NC287T	NC277T	NC297T

ISOTAN_F®

ND603 Metha® X-ray templates

Implant Materials:

ISOTAN_F®

PLASMAPORE® μ-CaP

Titanium forged alloy (Ti6Al4V/ISO 5832-3)
Surface coating pure titanium according to
ISO 5832-2 with additional calcium phosphate
coating



12/14



12/14

CERAMIC HEADS

Size	28 mm	32 mm	36 mm
S	NK324	NK424	NK524
M	NK325	NK425	NK525
L	NK326	NK426	NK526
XL	-	NK427	NK527

Isocer®

Size	28 mm	32 mm	36 mm	40 mm
S	NK460D	NK560D	NK650D	NK750D
M	NK461D	NK561D	NK651D	NK751D
L	NK462D	NK562D	NK652D	NK752D
XL	-	NK563D	NK653D	NK753D

BioloX® delta



12/14

METAL HEADS

Size	28 mm	32 mm	36 mm	40 mm	28 mm	< 32 mm
S	NK429K	NK529K	NK669K	NK769K	- 3.5 mm	- 4.0 mm
M	NK430K	NK530K	NK670K	NK770K	± 0 mm	± 0 mm
L	NK431K	NK531K	NK671K	NK771K	+ 3.5 mm	+ 4.0 mm
XL	NK432K	NK532K	NK672K	NK772K	+ 7.0 mm	+ 8.0 mm

ISODUR®_F

Relative neck length values for 12/14 modular heads.

Note:

Metha® hip stems can be not combined with XXL prosthesis heads.
 Metha® stem sizes 0 and 1 can be not combined with XL prosthesis heads.

Implantmaterialien:

Isocer® Ceramic (Al₂O₃/ZrO₂/ISO 6474-2)
 BioloX® delta Ceramic (Al₂O₃/ZiO₂/ISO 6474-2)
 ISODUR®_F Cobalt-Chromium forged alloy (CoCrMo/ISO 5832-12)

A series of horizontal dotted lines for writing, consisting of 25 lines spaced evenly down the page.

AESCULAP® – a B. Braun brand

Aesculap AG | Am Aesculap-Platz | 78532 Tuttlingen | Germany
Phone +49 7461 95-0 | Fax +49 7461 95-2600 | www.aesculap.com

The main product trademark "AESCULAP" and the product trademarks "Isocer", "ISODUR", "ISOTAN", "Metha", "MIOS", "Plasmafit", "PLASMAPORE" and "Viteline" are registered trademarks of Aesculap AG. "Biolox" is a registered trademark of CeramTec GmbH, Plochingen.

Subject to technical changes. All rights reserved. This brochure may only be used for the exclusive purpose of obtaining information about our products. Reproduction in any form partial or otherwise is not permitted.